

Data Sheet



Article number: 2314449506

Description: E+G rubber wheel 449506
RE.E2-100-RBL loose wheel

Measures

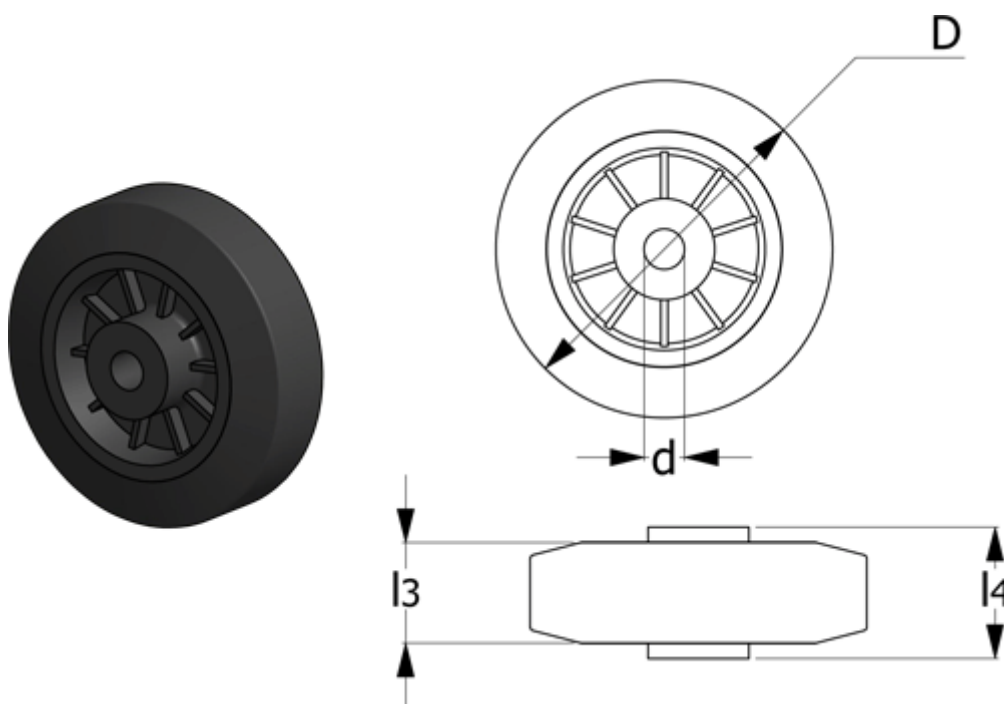

Code = 449506
d = 12
D = 100
Dynamic load (N) = 800
g = 210
l3 = 30
l4 = 44
Max static load (N) = 2000

Rolling resistance (N) = 750
Type = RE.E2-100-RBL